

Matter Webinar Series



1

23rd May 2023

Introduction to Matter

2

26th May 2023

Building a Matter Device

3

30th May 2023

**Matter Certification and
Device Certificates**

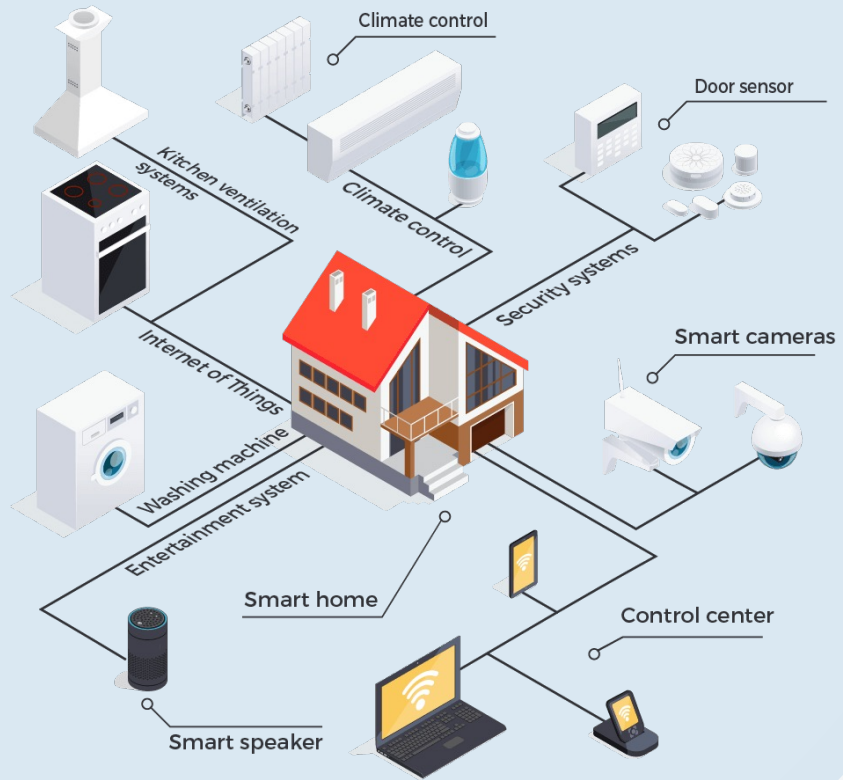

Matter Certification and Device Certificates

Espressif Systems

Agenda

- 1 | Matter Certification Process
- 2 | Device Attestation and Certificates
- 3 | Device Manufacturing
- 4 | How Espressif Helps Simplifying

1

Matter Certification Process

Why Matter Certification

- Seamless Interoperability amongst the devices is one of the key goals of Matter standard
- Certification helps to ensure the compliance to Connectivity Standards Alliance defined Matter specification and hence interoperability
- Certification and the Matter logo on the product helps the consumer to choose genuine certified products



Ways to Get Certification

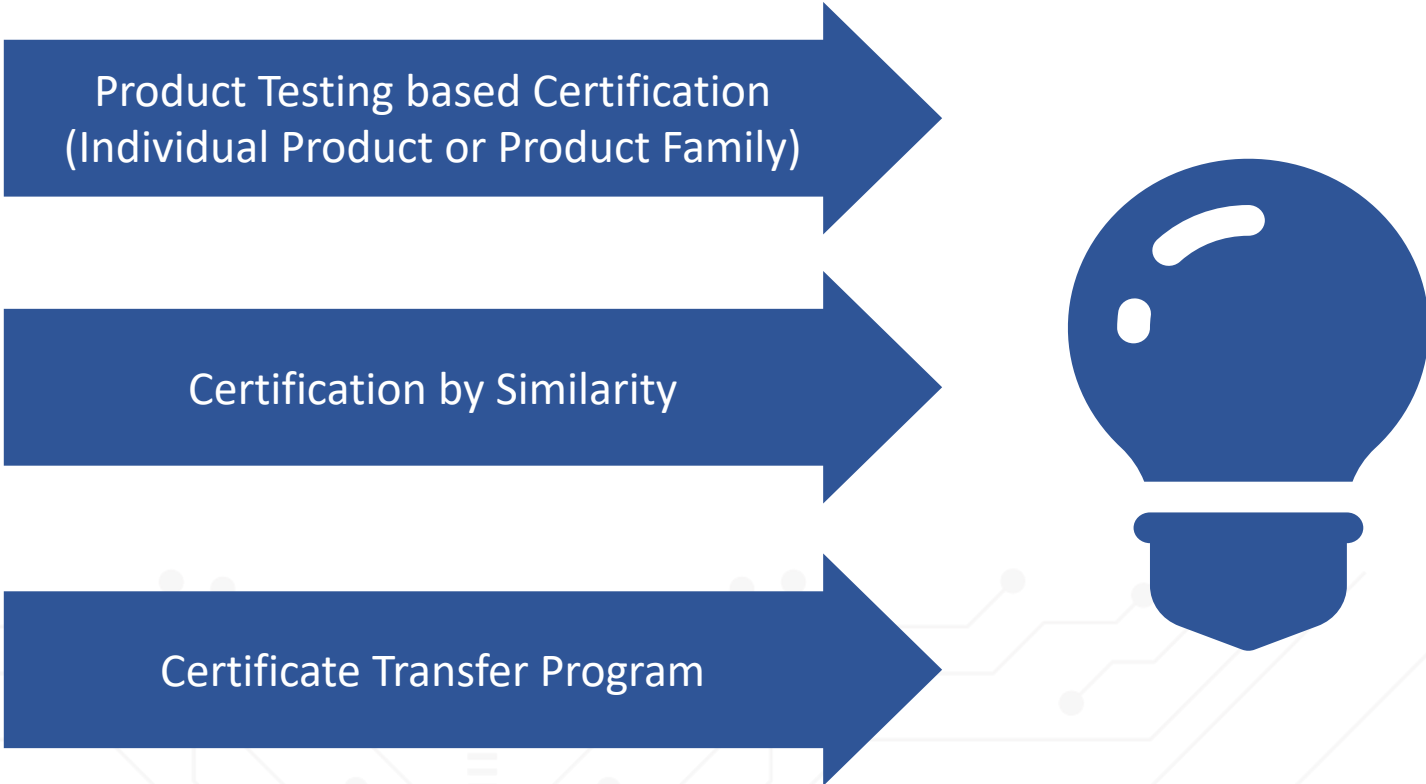

Product Testing based Certification
(Individual Product or Product Family)

Certification by Similarity

Certificate Transfer Program



Product Testing Based Certification Process Overview

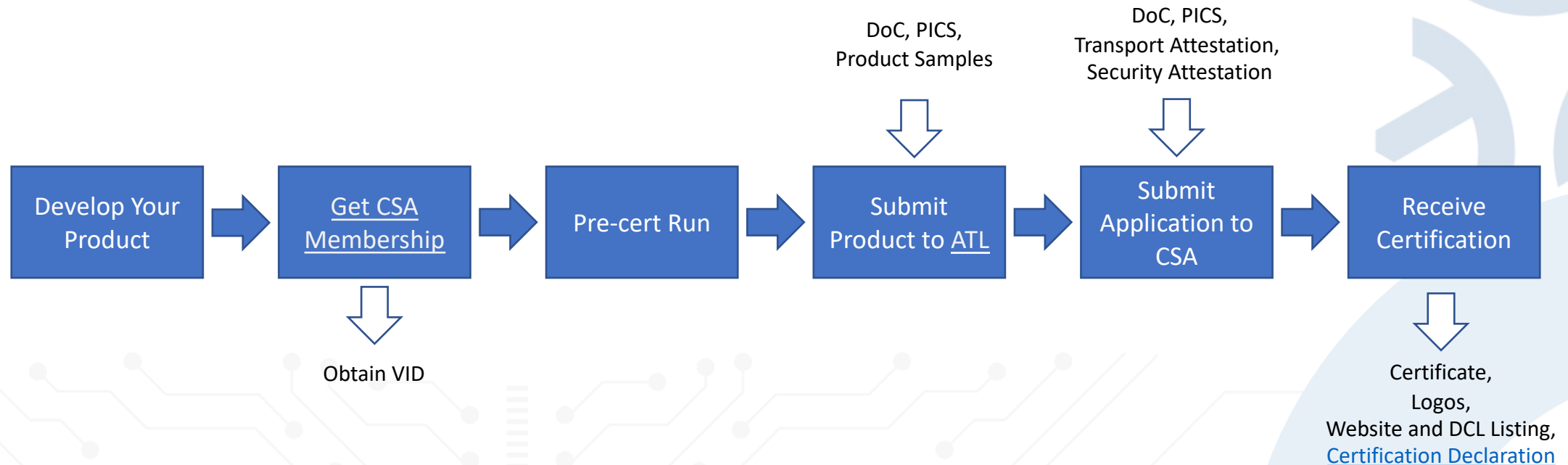

VID – Vendor ID

DoC – Declaration of Conformity

PICS – Protocol Implementation Conformance Statement

ATL - Authorized Test Lab

Transport Certifications

- Bluetooth SIG (LE v4.0 or later)
- Wi-Fi Alliance (802.11n or later)
- Thread (Thread 1.3 or later)
- Ethernet (IEEE PMA Compliance)

Certification by Similarity and Certification Transfer Program

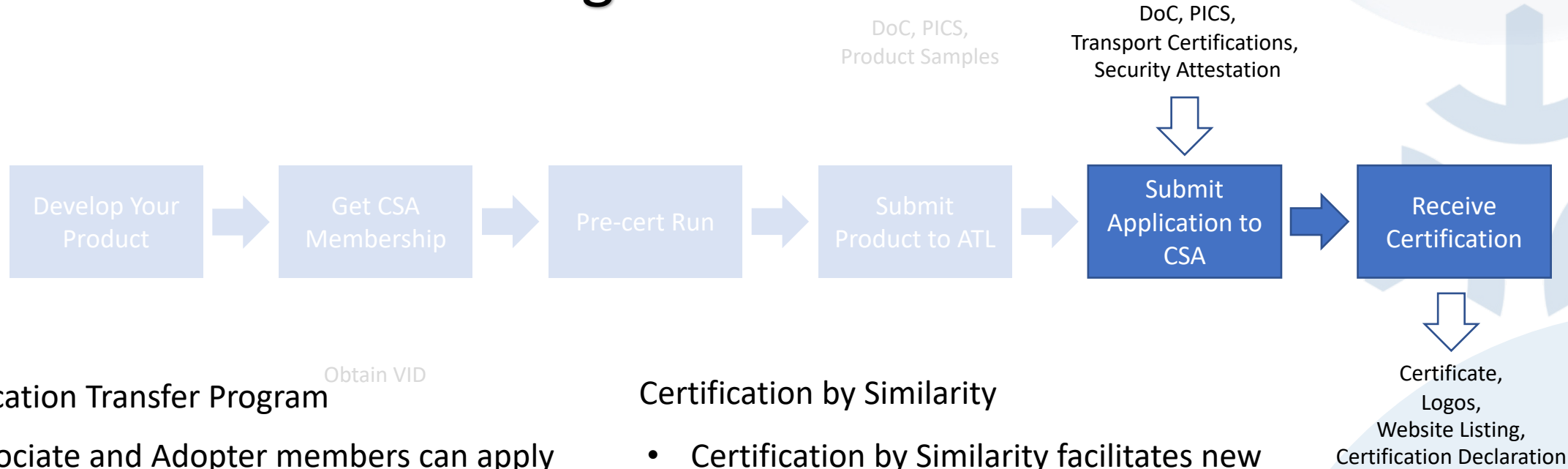

Certification Transfer Program

- Associate and Adopter members can apply for certificate transfer for the products certified by Promoter or Participant members
- This is to facilitate white labeling and re-branding
- Only packaging, enclosure and user interface changes allowed

Certification by Similarity

- Certification by Similarity facilitates new products certification by the same owner based on existing certified product
- The original product should run the same Matter software as of the new product

2

Device Attestation and Certificates

Attestation Goals

- Certification Attestation – The commissioner or any entity can ensure that the Matter device it's talking to has obtained a verifiable Matter certification
- Device Attestation - The commissioner or any entity can ensure that the specific Matter device it's talking to is genuinely manufactured
- Software Attestation – The version of the software that the Matter device is running, is Matter compliant (in case of OTA upgrades)
- All of this is cryptographically verifiable and happens without requiring a centralized server

Distributed Compliance Ledger



- Distributed Compliance Ledger is a non-centralized and cryptographically secured database
- The commissioner and other devices can read the DCL entries, verify the authenticity and use that as the root of trust for various attestations required

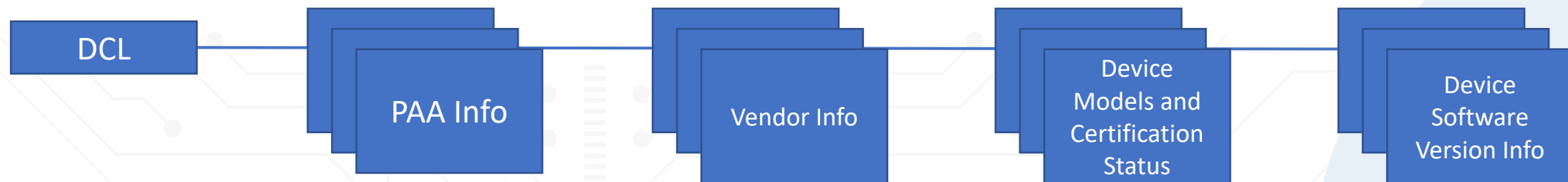

Device Attestation PKI

- Attestation works using PKI Cryptography
- Root of Trust begins with Product Attestation Authorities (PAA) Certificate list present in the DCL
- PAAs are first-level CA who can sign Product Attestation Intermediaries (PAI)
- PAI CAs can sign Device Attestation Certificates (DAC) that are unique for each Matter device
- The commissioner and other entities now can establish trust in the device with DAC using DCL

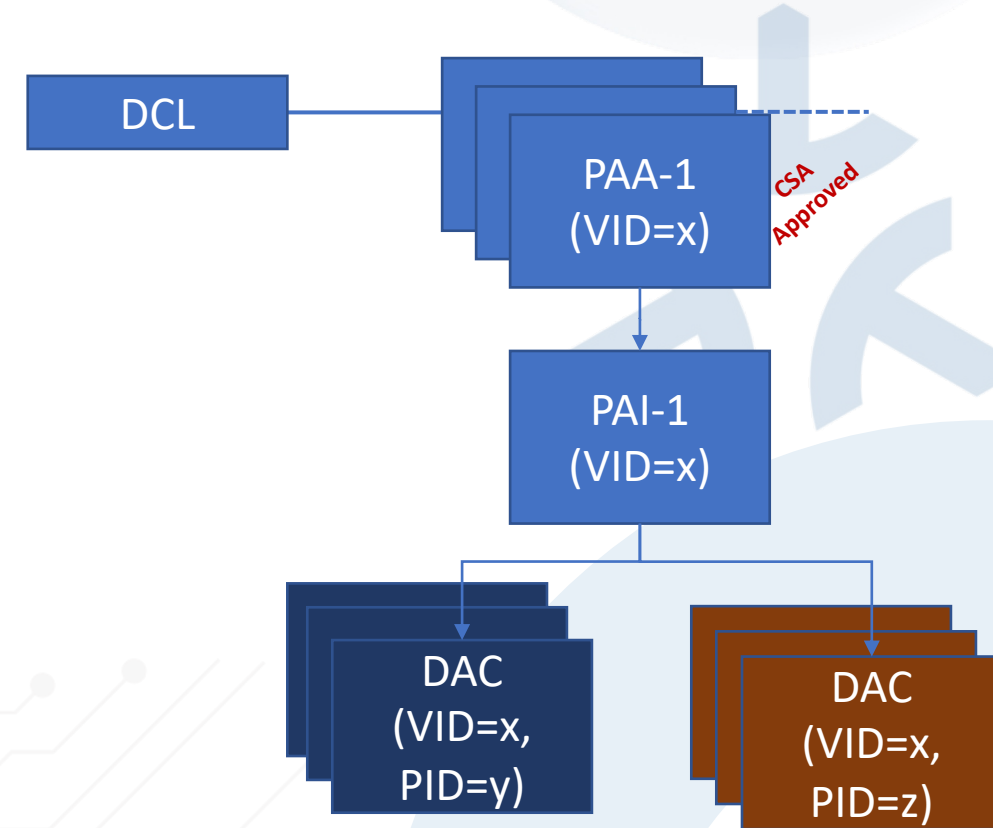

Device Manufacturing Requirements

- Each device needs to have a DAC that is signed using CSA-approved PAA
- DAC has a private key that acts as a key device identity and needs to be protected
- Additionally, each device needs to be programmed with a unique Passcode and a Verifier that goes into the QR code of the device

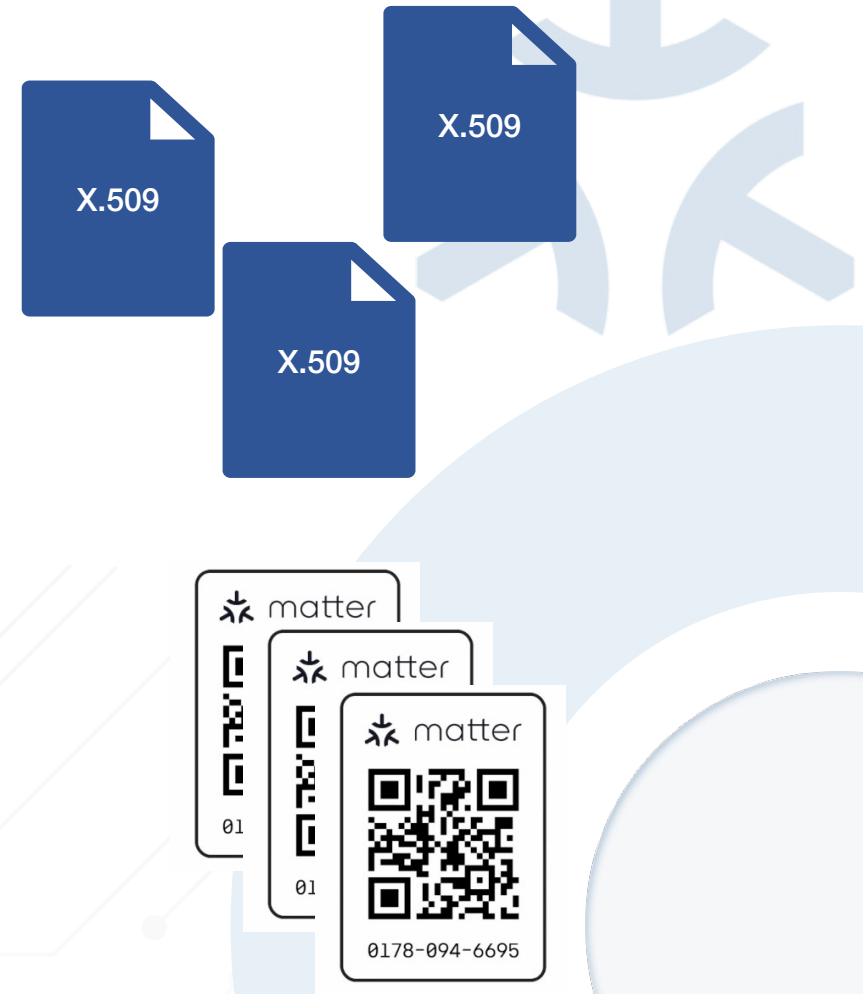

3

Espressif's DAC Pre-provisioning Service

Manufacturing Considerations

- Building your own DAC provisioning infrastructure can be complex and time consuming
- The factory needs to be secured to be able to work with cryptographic material
- PKI as a service platform can provide DAC but require equipment setup in your manufacturing factory; requiring upfront investment and time
- Unique data programming can take more time for each device on the manufacturing line

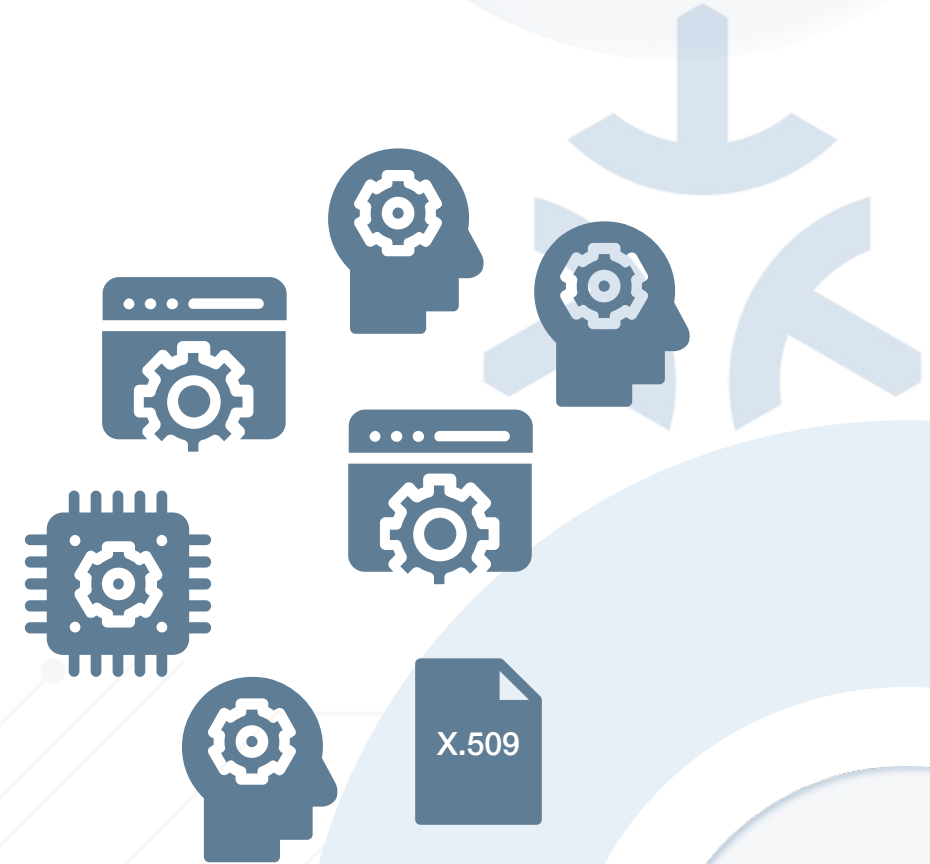

Espressif's DAC Provisioning Service



- Espressif is a CSA-approved PAA and has built secure certificate signing and manufacturing infrastructure
- Espressif offers DAC Pre-provisioning Service using which Espressif connectivity modules and SoCs can be pre-provisioned with DAC certificates securely in Espressif's factory
- Modules and SoCs are locked to ensure that the DAC private key and sensitive data can't be obtained by any entity except a trusted software executing on Espressif chips
- Modules and SoCs also get programmed with unique passcode and verifier that can be used in the device QR codes
- Customers receive the secured, pre-provisioned modules and a database of module IDs, certificates, passcode and verifier



4

ESP ZeroCode Modules

ESP ZeroCode Modules

What if I don't want to do my own development and build a simple device such as Smart Switch, Light, or Blinds Controller? Certification and manufacturing is too complicated for me.

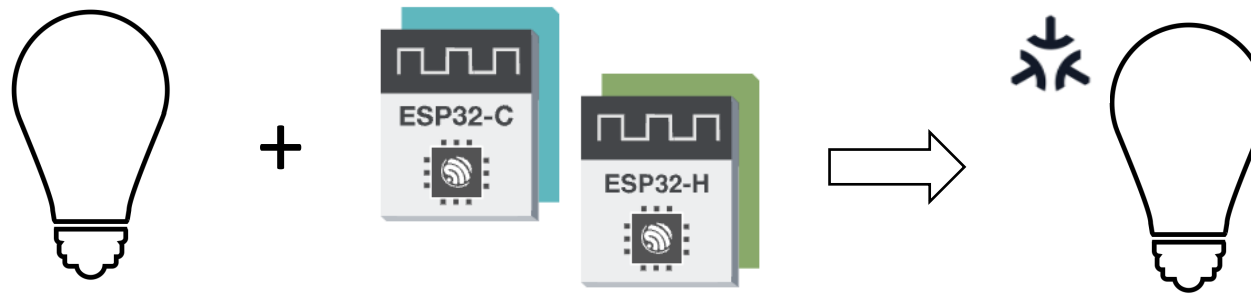

- ESP ZeroCode Modules are pre-programmed, pre-provisioned Matter-certified modules that can directly be used to build Wi-Fi or Thread Matter end-devices
- Common device types with standard functionality can be supported – e.g. lights, sockets, switches, fan controllers, blinds controllers
- ESP ZeroCode Modules support both – Matter over Wi-Fi and Matter over Thread accessories

Advantages

- The simplest way to create Matter-enabled devices – Just to integrate the modules in your device
- Matter certification is maintained by Espressif
- With Matter, no custom phone apps and voice assistant skills are required – again reduced engineering
- Works with all Matter-compatible ecosystems such as Alexa, Google, Apple, and Samsung and gets remote control of the device through their apps
- Device management and OTA dashboard for all the devices
- Optional ESP RainMaker Cloud Connectivity

How can I Try Out?

<https://zerocode.espressif.com>



Demo Video to be played here



5

Espressif's Certification Assistance Service

Certification Assistance Service



- Espressif's Matter Certification Assistance Service helps customers to carry out their product certification benefiting from Espressif's experience of Matter Certification
- Espressif can work with the lab to assist complete certification for customers' products
- Espressif can assist customers to run pre-cert test runs in Espressif's lab to ensure that the product passes all tests
- Espressif customers can benefit from a pre-negotiated certification price from an ATL if they want to go for certification directly

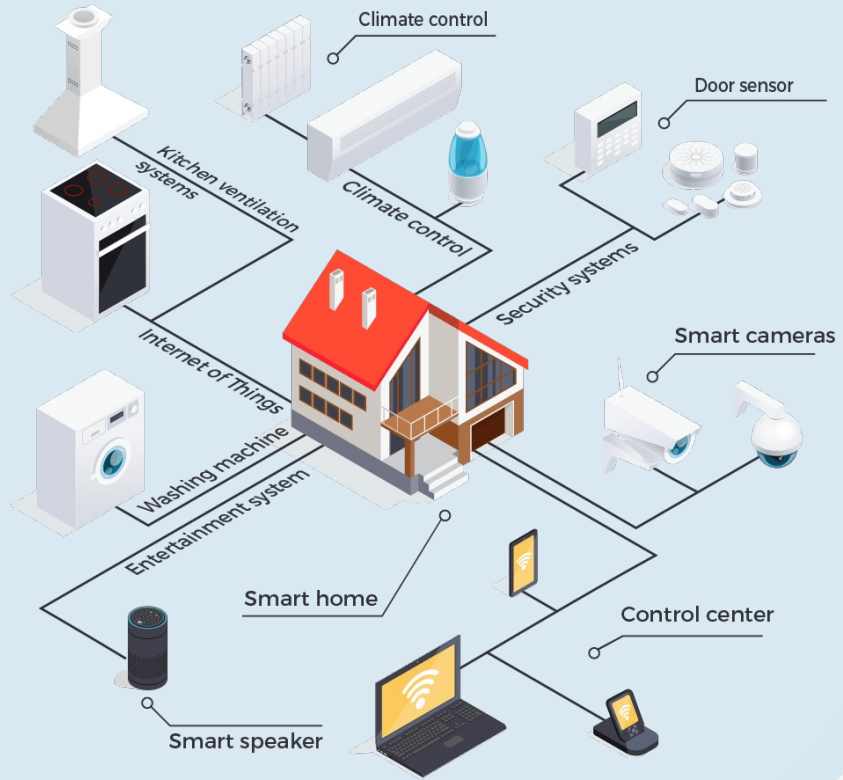

Thank You!

Any Questions?

CSA Membership

Associate Member



Free Membership; White Label or Rebrand a Certified Product

Adopter Member



Paid Membership; Develop, Test, and Certify a Product

Participant Member

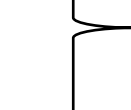

Promoter Member

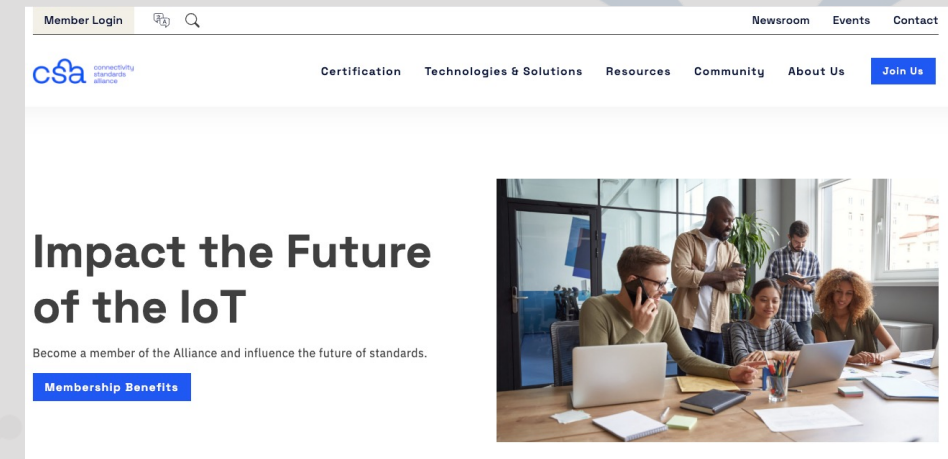

<https://csa-iot.org/become-member/>

[Back](#)

CSA Authorized Test Labs

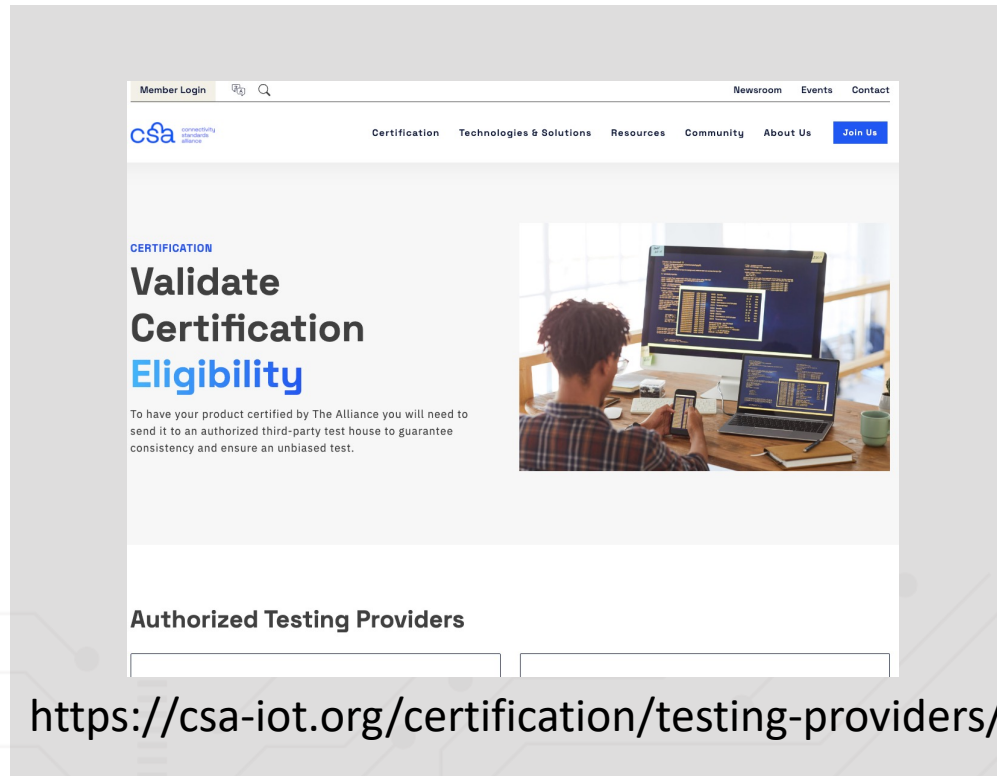

The screenshot shows the CSA website's 'Authorized Testing Providers' page. The header includes 'Member Login', 'Newsroom', 'Events', and 'Contact'. The main navigation bar contains 'Certification', 'Technologies & Solutions', 'Resources', 'Community', 'About Us', and a 'Join Us' button. The main content area features a 'CERTIFICATION' section with the heading 'Validate Certification Eligibility' and a sub-heading 'Authorized Testing Providers'. Below the heading is a search bar. The page also includes a navigation menu with 'Member Login', 'Newsroom', 'Events', and 'Contact'. The main navigation bar contains 'Certification', 'Technologies & Solutions', 'Resources', 'Community', 'About Us', and a 'Join Us' button. The main content area features a 'CERTIFICATION' section with the heading 'Validate Certification Eligibility' and a sub-heading 'Authorized Testing Providers'. Below the heading is a search bar.

<https://csa-iot.org/certification/testing-providers/>

Authorized Test Labs Listing

[Back](#)

Certification Declaration

- Certification Declaration is a blob signed by CSA that contains product certification information
- Certification Declaration is present in the device and the matching certification information is present the DCL
- Certification Declaration has the following main information
 - Vendor ID and a list of product IDs
 - Device Type
 - Certification Type (Dev/Test Certificate, Provisional, Official)
 - Optional DAC Origin Vendor ID and DAC Origin Product ID
 - Optional PAA list